



The EB2 is a compact, factory-sealed inground luminaire engineered for durability in harsh exterior environments. With a corrosion-resistant brass body, IP68 rating, and micro-antileach cable entry, it ensures long-term reliability in coastal, urban, or high-moisture settings—no drainage required. Ideal for wayfinding, perimeter lighting, or ambient highlights, the EB2 delivers functional illumination while preserving design intent without adding visual clutter.

The EB2 supports Static White output and comes as DALI controllable or non-dim.

The cast 316 stainless steel top offers superior corrosion resistance; the naturally patterned crystalline surface is indicative of its high-alloy composition, highlighting durability in high-salinity, high-exposure environments.

Drive-over rated and compact at 4.7" (120 mm) diameter, the EB2 delivers up to 65 lm per aperture. It installs easily via direct burial, pre-installation kits, or a 4" conduit system, making it ideal for discreet yet powerful architectural or landscape lighting.

Performance

Static White	Lumen Output per Aperture (lm)	Peak Intensity (cd)
● 2,700 K (80 CRI)	60	41
● 3,000 K (80 CRI)	60	41
○ 3,500 K (80 CRI)	60	41
● 4,000 K (80 CRI)	65	46

Power Consumption

Voltage	Control	Market	Nominal Power Consumption		
			1 Aperture	2 Aperture	4 Aperture
Mains Voltage	DALI	International	3	5	9
		North America	5	5	10
	Non-Dim	International	3	5	9
Low Voltage	Non-Dim	International	5	5	10
		North America	5	5	10



Products and specifications are subject to change without notice. LS3722_250804

Electrical

Power Consumption	Refer to table
Lifetime	76,554 hours @ 25°C Ambient (B10, L90, TM21 Projected)
Input Voltage	International: 220-240 V AC, 50 Hz North America: 120 V AC, 60 Hz Low Voltage: 24 V DC
Thermal Management	CoolDrive™ onboard thermal monitoring and control

Control

Protocols	DALI® (International), Non-Dimmable
------------------	-------------------------------------

Physical

Housing	Die-cast brass body with stainless steel lid
Installation	Pre-Installation blockout for concrete pour, drive-over and general use applications. Conduit Mount for mounting in 4" SCH 40 conduit by others. Direct burial for landscapes, planters and special applications.
Adjustability	
Wiring	84 (flexible cable), 82 (½" NPT) Direct Burial and Pre-Install
Ambient Operating Temperature	-40°F to 122°F (-40°C to 50°C)
Surface Temperature	< 149°F (< 65°C)
Weight	4.9 lb (2.2 kg)
Drive-Over	With pre-installation kit (LS6388) installed in concrete as per instructions ³

³ With soft tires at low speed, no braking or changing direction.

Certification & Compliance

IP Rating	IP68
IK Rating	IK10
Static Load Rating	6,614 lb (3,000 kg)
Environment	Dry, Damp, Wet Locations Inherently protected Suitable for use in poured concrete No drainage required
Certifications	UL (USA & Canada), CE, RCM, FCC

Dimensions - Direct Burial

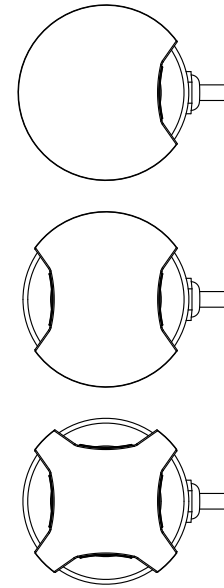
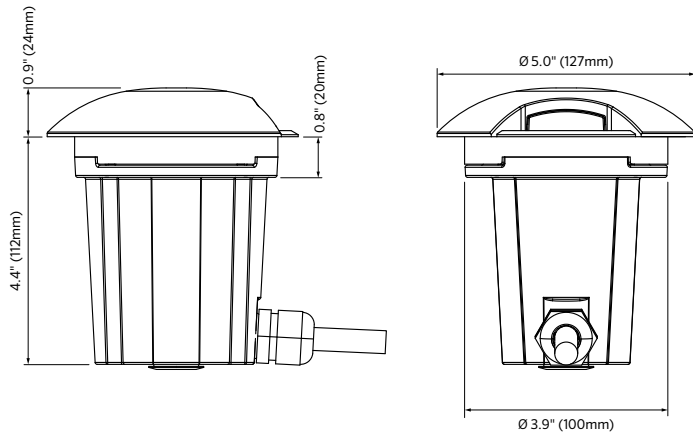

Dimensions - Pre-Install (LS6388)

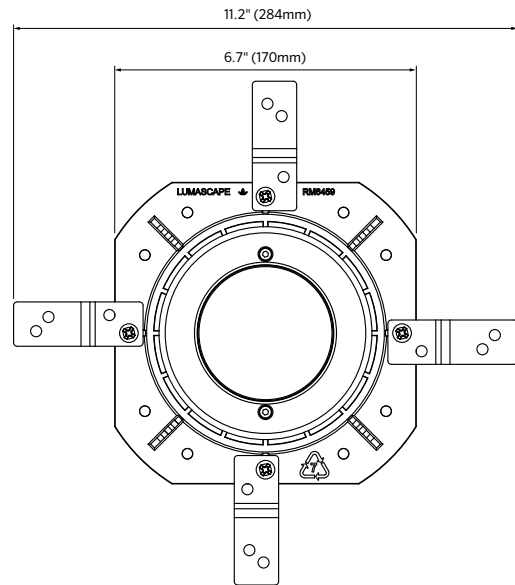
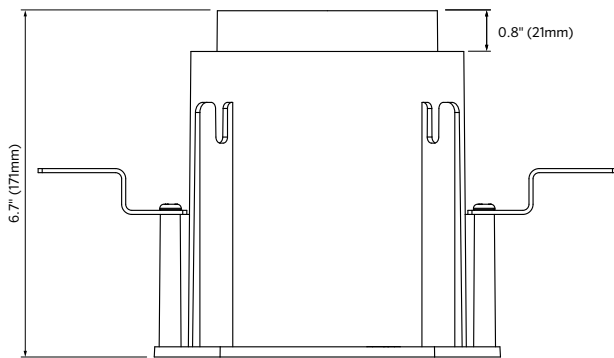

Dimensions - Conduit Mount (LS6389)

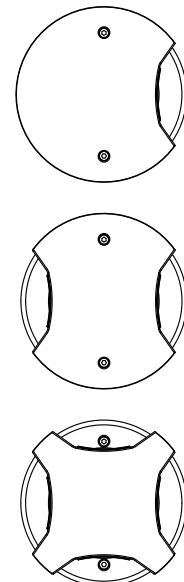
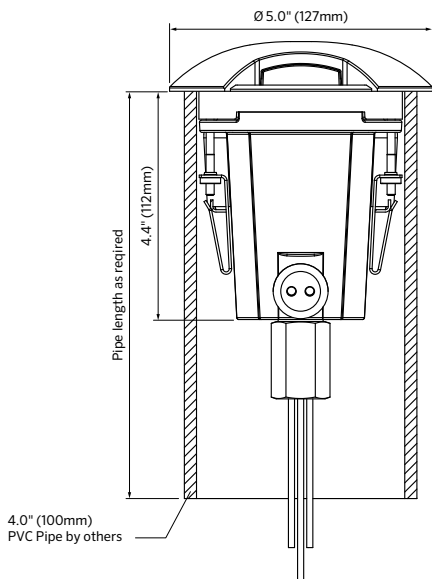

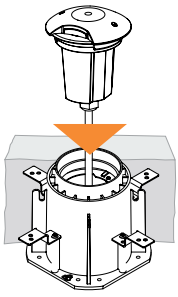

Pre-Installation Blockout

This type of installation requires the LS6388 Pre-Installation Kit (ordered separately), which acts as a concrete blockout and is intended for installation before the luminaire. This method ensures the luminaire itself is not damaged during concreting or other site works.

Used for	Drive over applications General use applications Concrete pour applications where luminaire is to be installed after site work has been completed.
Benefits	Easy removal for servicing
Accessories	LS6388 Pre-Installation Blockout

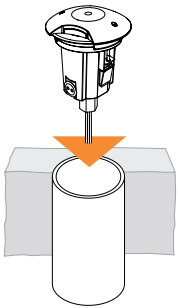

Conduit Mount

This type of installation allows the luminaire to be installed and locked into a standard schedule 40, 4" (100mm) conduit (supplied by others). This ensures the luminaire itself is not damaged during concreting or other site works. Once all the site work is completed the luminaire can be installed.

Used for	Drive over applications General use applications Concrete pour applications where luminaire is to be installed after site work has been completed.
Benefits	Easy removal for servicing Schedule 40, 4" (100mm) conduit can be procured locally, prior to delivery of luminaire.

Connection type '84'

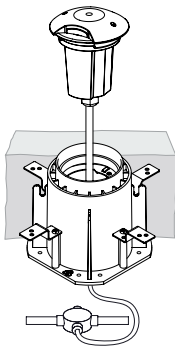

Flexible Cable

For connections to the branch circuit via junction box (by others) or other approved method. 6.5' (2 m) length. For other length options, contact Lumascape.

Connection type '82'
North American market only

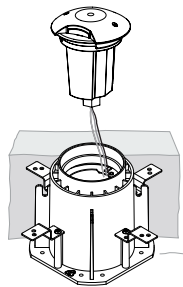

1/2" NPT Adapter

The luminaire is factory-fitted with 6.5' (2 m) hookup wire. Ensure terminations can be made within this length. For other length options, consult Lumascape.

Aperture Configurations

The SS316 turret tops are available in a one, two and four aperture configuration as standard. The LS6388 pre-installation kit uses special seals and support bushes to ensure static loads up to 6,614 lb (3,000 kg) are properly supported.



One Aperture



Two Aperture



Four Aperture

Turret Top

■ SS316: Electro Polished

Pre-Installation Specification Matrix

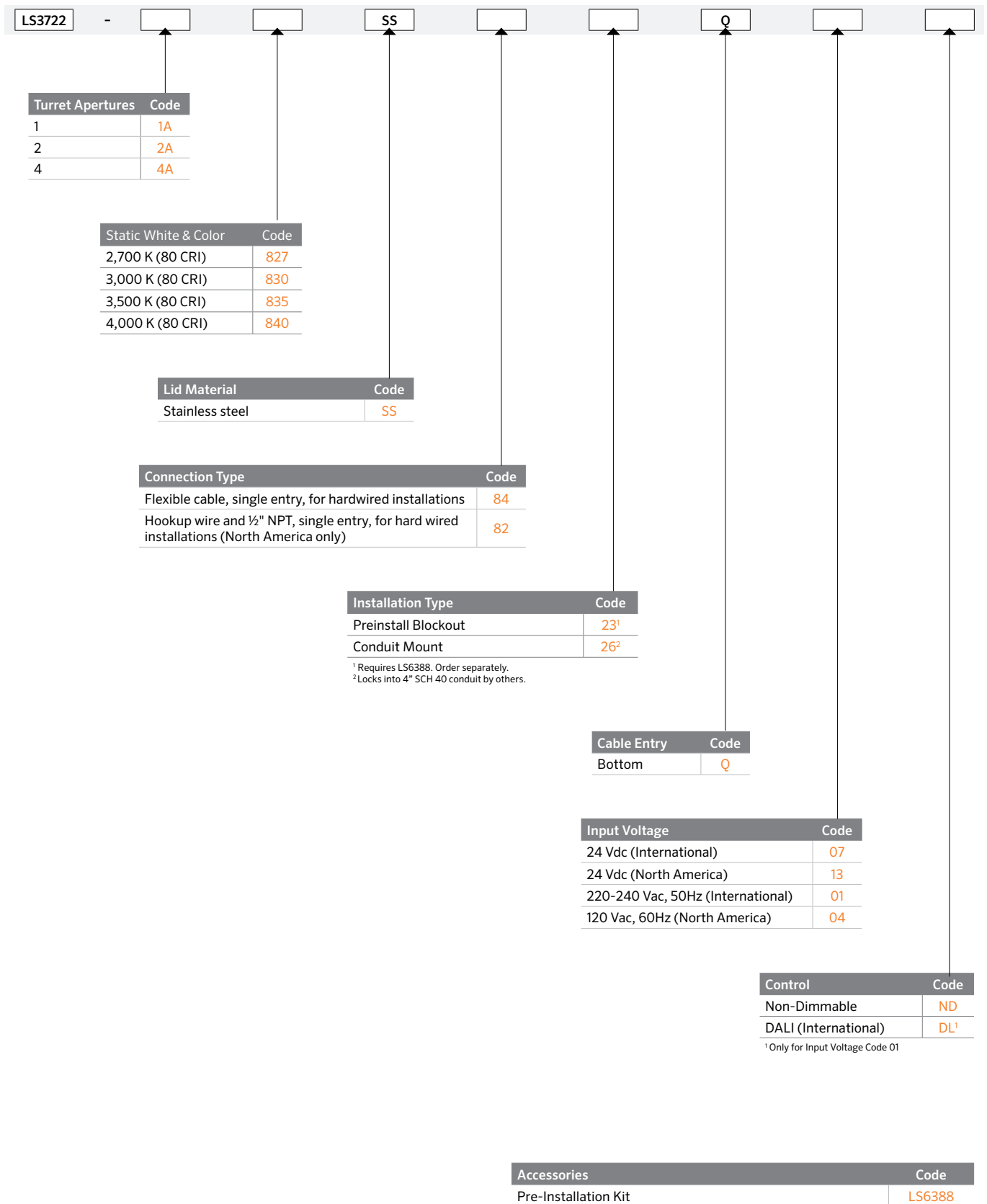

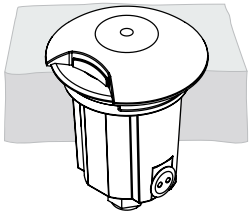

Direct Burial

Luminaire is installed directly into soil or soft landscapes.

Used for	Landscaping areas Applications where depth is restricted
Benefits	Simple installation Easy repositioning as landscapes evolve
Restrictions	Not suitable for drive-over (requires pre-installation) Connection Type 82 only available for North American market.

Connection type '84'

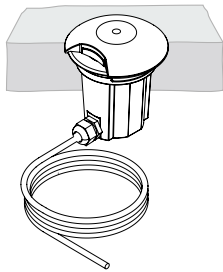

Flexible Cable
For connections to the branch circuit via junction box (by others) or other approved method. 6.5' (2 m) length. For other length options, contact Lumascape.

Connection type '82'
North American Market only

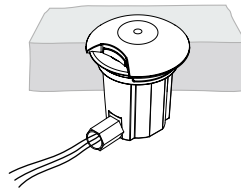

1/2" NPT Adapter
The luminaire is factory-fitted with 6.5' (2 m) hookup wire. Ensure terminations can be made within this length. For other length options, contact Lumascape.

Aperture Configurations

The SS316 turret tops are available in a one, two and four aperture configuration as standard.



One Aperture



Two Aperture



Four Aperture

Turret Top

■ SS316: Electro Polished

Direct Burial Specification Matrix

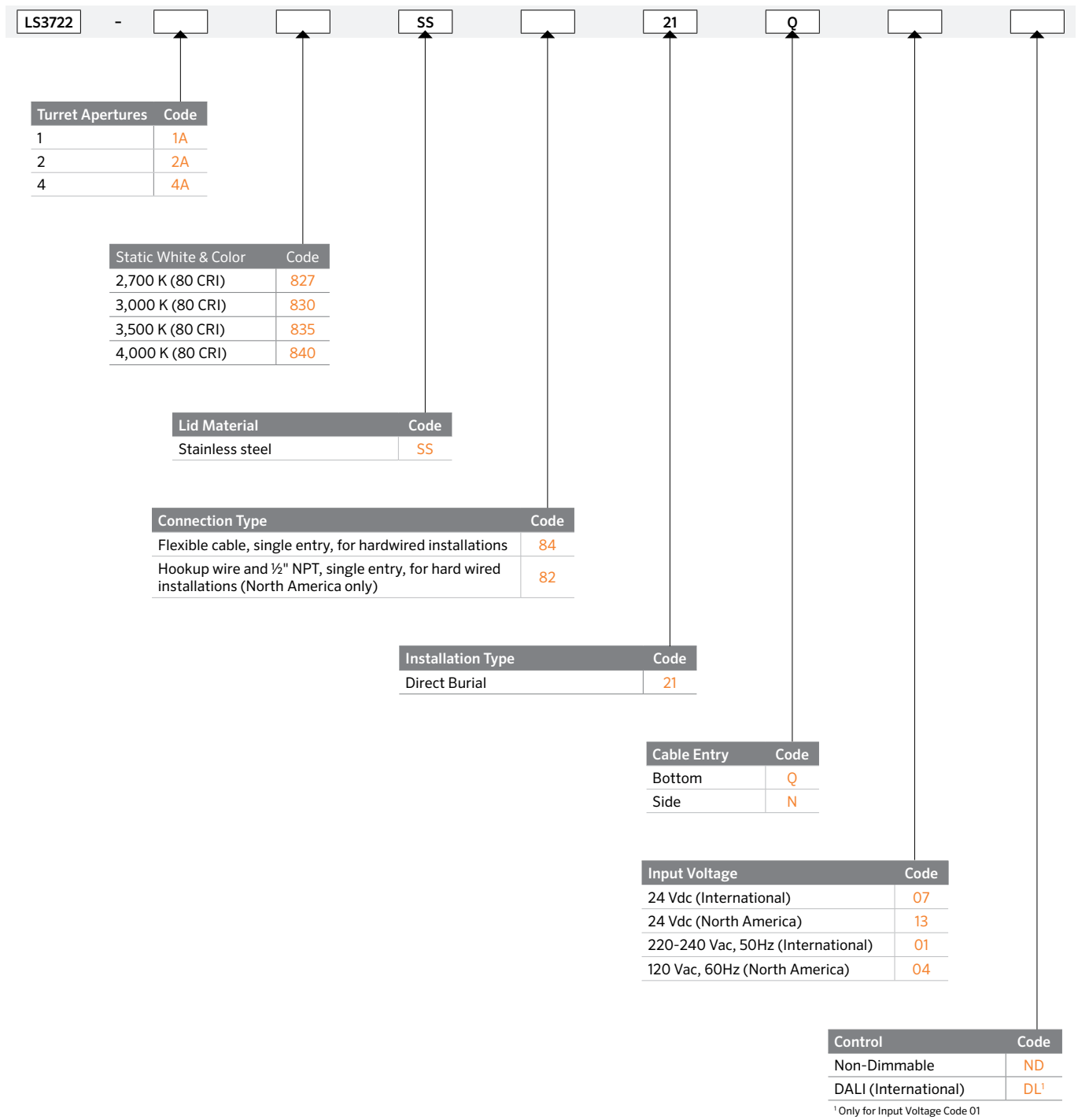

Network Topology - Line Voltage 220 to 240 Vac, 120/277 Vac Non-Dimmable

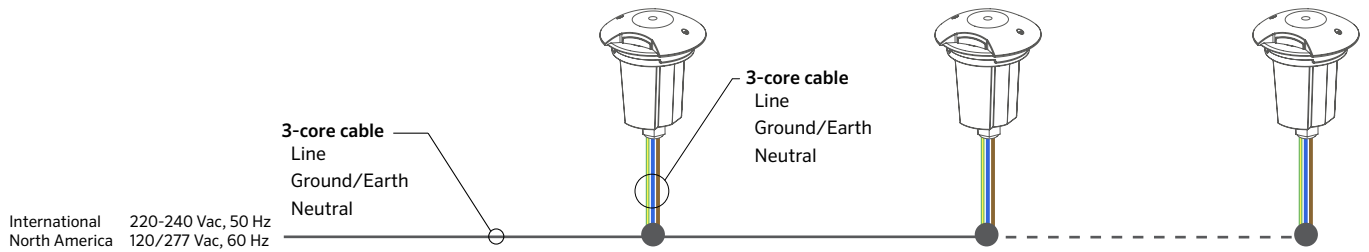

Network Topology - Line Voltage 220 to 240 Vac DALI

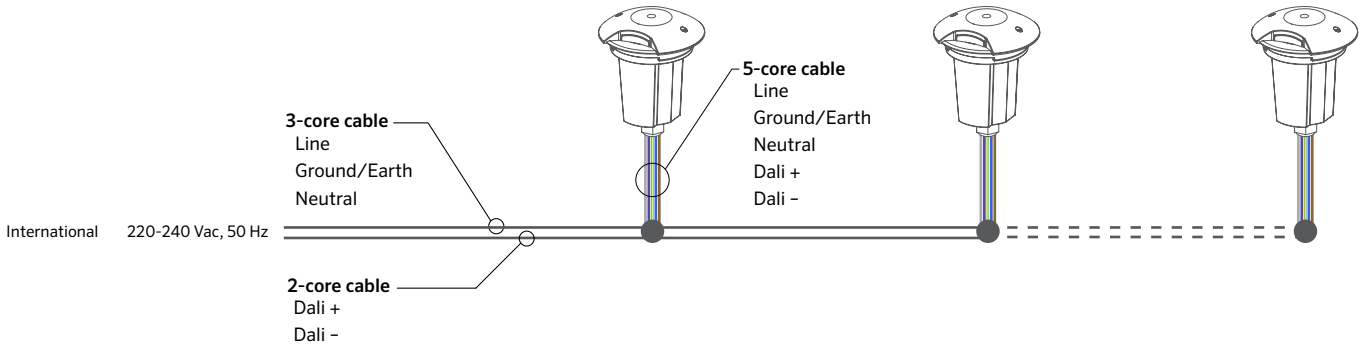

Network Topology - Low Voltage 24 Vdc, Non-Dimmable

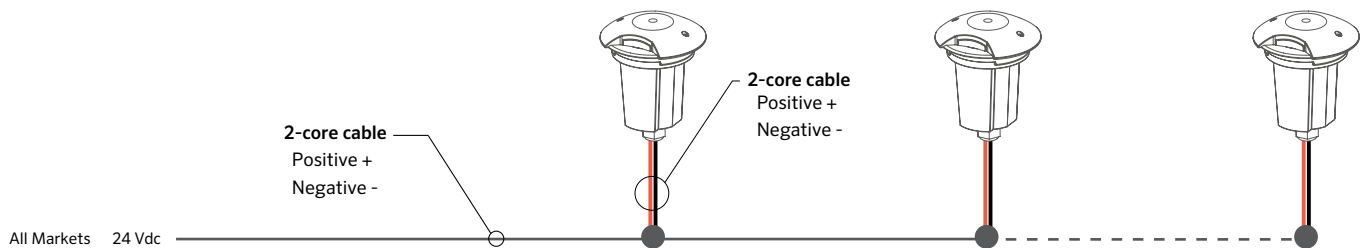

- Refer to "Transformer Compatibility Table", for maximum number of luminaires
- Calculations based on 14 AWG (2.5 mm²) trunk cable, and 16' (5 m) trunk cable between luminaires.
- Always observe local electrical codes for branch circuit current limitations
- For other configurations, contact Lumascape.

Transformer Compatibility Table

Supply Voltage	Luminaire Power	Max. Leader Cable Length from Power Supply to First Luminaire	Maximum Number of Luminaires per Power Supply				
			120 W	240 W	320 W	480 W	600 W
24 Vdc	5 W	50' (15 m)	16	17	17	17	17
		98' (30 m)	14	15	15	15	15
		164' (50 m)	12	12	12	12	12

Luminaire Wire Colors & Designations

Non-Dimmable Line Voltage 220-240 Vac - International

Designation	Color
Line	Brown
Neutral	Blue
Ground/Earth	Green / Yellow

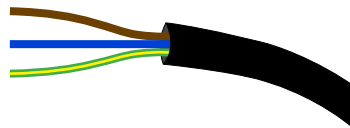

DALI Line Voltage 220-240 Vac - International

Designation	Color
Line	Brown
Neutral	Blue
Ground/Earth	Green / Yellow
DALI +	Grey
DALI -	Black



Non-Dimmable Line Voltage 120 - North America

Designation	Color
Line	Black
Neutral	White
Ground/Earth	Green / Yellow

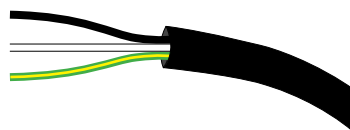

Low Voltage 24 Vdc

Designation	Color
Positive	Red
Negative	Black

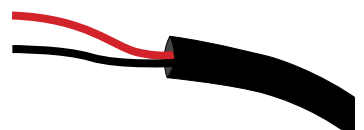

Accessories

Pre-Installation Kit

This type of installation requires the **LS6388** Pre-Installation Kit (ordered separately), which acts as a concrete blockout and is intended for installation before the luminaire. This method ensures the luminaire itself is not damaged during concreting or other site works.

LS6388	
Product	Code
Pre-Installation Kit	LS6388

