



The Erden E8 is a high-powered, in-ground uplighter that combines technology and performance in a modern form factor. Packed with features including EasyGlow™ and CoolDrive™ thermal management technologies. PowerSync™ allows for highly granular digital control via common protocols. Available in white, color-changing and tunable white light engines.

Performance

Static White & Color <sup>1</sup>	Lumen Output (lm)	Efficacy (lm/W)	Peak Intensity (cd)
● 2,700 K (80 CRI)	3,360	83	139,500
● 3,000 K (80 CRI)	3,510	86	145,400
○ 3,500 K (80 CRI)	3,880	92	176,300
● 4,000 K (80 CRI)	3,790	93	157,300
● 5,000 K (70 CRI)	3,510	86	145,400

<sup>1</sup> Lumen output values are based on a 6° lens.

Dynamic Color <sup>2</sup>	Lumen Output (lm)	Efficacy (lm/W)	Peak Intensity (cd)
● RGBA	1,760	49	61,000
● RGBW (4,000 K) with Royal Blue*	1,970	53	73,100

<sup>2</sup> Lumen output values are based on a 6° lens.

Tunable White <sup>3</sup>	Lumen Output (lm)	Efficacy (lm/W)	Peak Intensity (cd)
● 2,700 K - 6,500 K	3,580	88	148,400

<sup>3</sup> Lumen output values are based on a 6° lens.

Beam Angles	6°, 10°, 15°, 30°, 45°, 60°, 10° x 40°, 40° x 10°, 10° x 60°, 60° x 10°, 20° x 40°, 40° x 20°, 20° x 60°, 60° x 20°
-------------	---

! Other LED colours and CRIs available on request. Contact Lumascape for options.



Products and specifications are subject to change without notice. LS3080\_260525

### Electrical

<b>LED Power</b>	30 W	
<b>Power Consumption</b>	≤ 40 W	
<b>Lifetime</b>	> 60,000 hrs (B10, L70, TM21)	
<b>Input Voltage</b>	International	220-240 Vac, 50/60 Hz
	North America	120/277 Vac, 60 Hz
	All Markets	30-48 Vdc
<b>Earth Leakage</b>	0.3mA @ 120 Vac, 0.4mA @ 240 Vac, 0.6mA @ 277 Vac	
<b>Thermal Management</b>	CoolDrive™ onboard thermal monitoring and control	

### Control

<b>Interface</b>	Lumascap PowerSync®	
<b>Protocols<sup>1</sup></b>	DMX/RDM, Artnet, PWM <sup>2</sup> , 0-10 V (sink or source) <sup>2</sup>	
<b>PWM Frequency</b>	2 kHz flicker-free dimming to 0.1%	
<b>RDM Functionality</b>	PowerSync enabled Lumascap luminaires are shipped with a default RDM personality which provides smooth dimming control. For different dimming characteristics or to enable other special functionalities, the default personality can be changed through industry standard DMX/RDM.	
<b>Systems</b>	Range of third-party controllers	

<sup>1</sup> Some protocols require additional hardware. For more information and other available protocols contact Lumascap.

<sup>2</sup> Not available for color-changing or tunable white

### Physical

<b>Housing</b>	Marine-grade 316 stainless steel housing, cover (polished or brushed finish), high-strength glass and teflon-coated cover screws.	
<b>Finish</b>	Superior 9-step powder-coating process, including marine-grade epoxy undercoat and polyester top-coat	
<b>Installation</b>	Pre-Installation blockout for concrete pour, drive-over and general use applications. Mounting collar for decks and grates. Direct burial for landscapes, planters and special applications.	
<b>Mounting Accessories</b>	LS640-K Pre-installation concrete blockout LS640-2 Mounting collar for decks and grates	
<b>Adjustable</b>	-5° to +20° tilt, 360° rotation	
<b>Ambient Operating Temperature</b>	-4°F to 122°F (-20°C to 50°C)	
<b>Surface Temperature</b>	≤149 °F (65 °C)	
<b>Weight</b>	15.0 lbs (6.8 kg)	
<b>Drive-Over</b>	With OptiClear lens and pre-installation kit (LS640-K)	

### Certification & Compliance

<b>IP Rating</b>	IP68	
<b>IK Rating</b>	IK10	
<b>Static Load Rating</b>	9,259 lbs (4,200 kg)	
<b>Environment</b>	Dry, Damp, Wet locations Inherently protected Suitable for use in poured concrete	
<b>Certifications</b>	UL, CE, UKCA, RCM, CCC	

Accessories

Shielding & Glare Control

A range of shielding and glare control accessories are available to suit the Erden E8 In-ground.

**LS6235** Diffusion Media

Modifies the harsh quality of light being dispersed by the luminaire by spreading the beam. Order separately.



OR

**LS6234** Cross Hatch Louver

Provides additional glare control. Available in black only. Order separately.



Specification Matrix

LS6235	-	
--------	---	--

Degree	Code
10°	10
20°	20
30°	30
40°	40

Technical Drawings

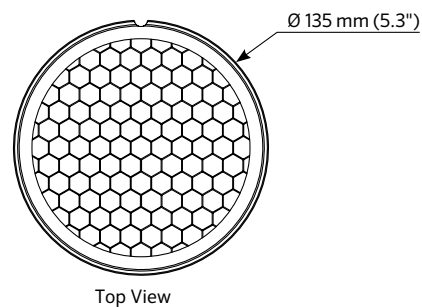

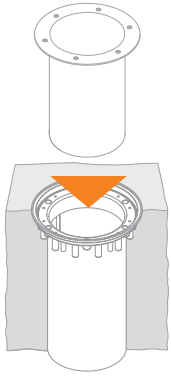

**Pre-Installation**

This type of installation requires the **LS640-K Pre-Installation Kit** (ordered separately), which acts as a concrete blockout and is intended for installation before the luminaire. This method ensures the luminaire itself is not damaged during concreting or other site works.

<b>Used for</b>	Drive over applications General use applications Concrete pour applications where luminaire is to be installed after site work has been completed.
<b>Benefits</b>	Easy removal for servicing
<b>Restrictions</b>	Connection Type 82 only available for North American market
<b>Accessories</b>	<b>LS640-K</b> Pre-Installation Blockout

**Connection type '84'**

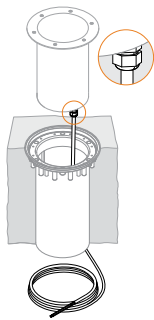

**Flexible Cable**

For connections to the branch circuit via junction box (by others) or other approved method. 6.5' (2 m) length. For other length options, contact Lumascape.

**Connection type '82'**  
North American market only

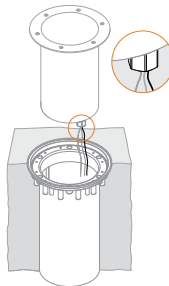

**1/2" NPT Adapter**

The luminaire is factory-fitted with 6.5' (2.0 m) hookup wire. Ensure terminations can be made within this length. For other length options, consult Lumascape.

**Connection type '77/87'**

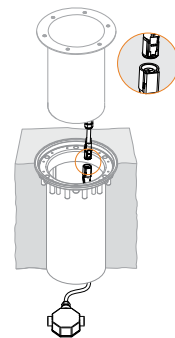

**IP68 Connector & Junction Box**

The luminaire is fitted with an IP68 connector, which attaches directly to the cable supplied with LS640-K without the use of any tools. The cable is 3' (1 m) in length and is supplied with a junction box.

**Flush Cover Options**

Flush covers for pre-installation use special seals and support bushes to ensure static loads up to 9,259 lbs (4, 200 kg) are properly supported. In order to achieve this drive-over rating, OptiClear™ or GripGlass™ must be used.



**Pre-Installation Blockout Round Flush Cover**

- SS316: Polished
- SS316: Brushed

**Specification**

Use the table below to specify your Pre-Installation Blockout.

<b>LS640-K</b>		-		
<b>Connection Type</b>		<b>Code</b>	<b>Input Voltage</b>	
Flexible cable, single entry, for hardwired installations (International) or Hookup wire and 1/2" NPT (82), single entry, for hard wired installations (North America only)		84	220-240 Vac, 50/60 Hz (International)	01
Flexible cable, single entry, for connectorized installations		77	120/277 Vac, 60 Hz (North America)	09
Flexible cable, single entry for connectorized installations (non-dimmable applications only)		87		

Technical Drawings - Pre-Installation Kit

Connection type '77'

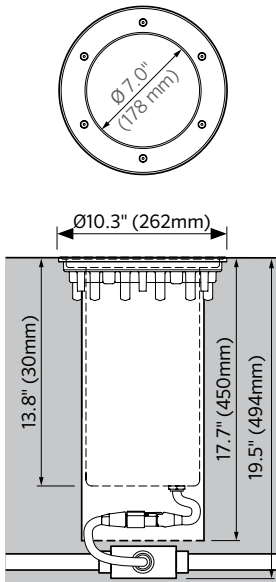

Connection type '87'

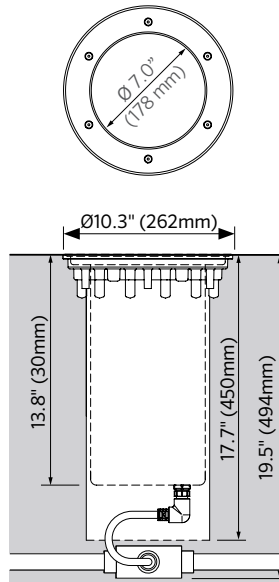

Connection type '82'  
North American Market only

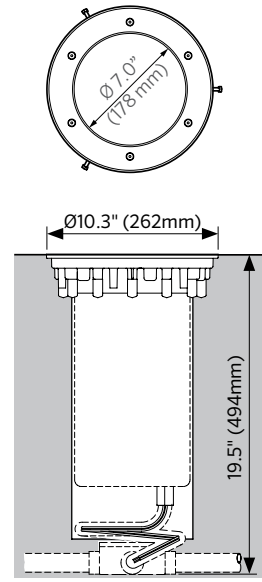

Connection type '84'

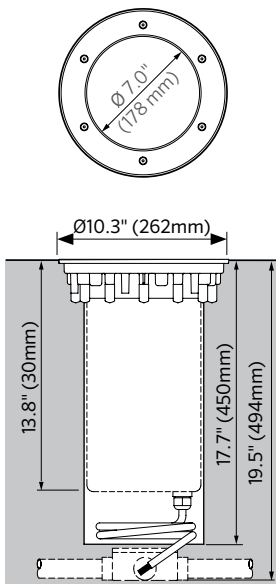

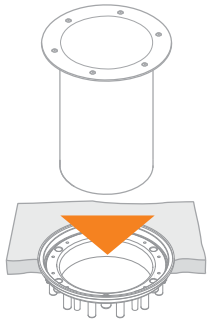

### Mounting Collar for Decks and Grates

This type of installation requires the **LS640-2 Mounting Collar** (ordered separately), which supports the installation in decks, grates and hollow floors with sufficient ventilation.

*Not available in North America.*

<b>Used for</b>	Decks and grates Hollow floors with sufficient ventilation
<b>Benefits</b>	Easy installation in decks, grates and hollow floors
<b>Restrictions</b>	Connection Type 84 only available for International market
<b>Accessories</b>	LS640-2 Mounting Collar

### Connection type '84'

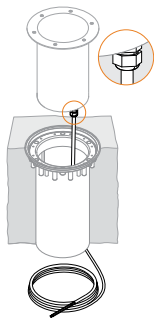

#### Flexible Cable

For connections to the branch circuit via junction box (by others) or other approved method. 6.5' (2 m) length. For other length options, contact Lumascape.

### Flush Cover Options

Flush covers for mounting collar use special seals and support brushes.

*Not suitable for use in North America.*



#### Pre-Installation Blockout Round Flush Cover

- SS316: Polished
- SS316: Brushed

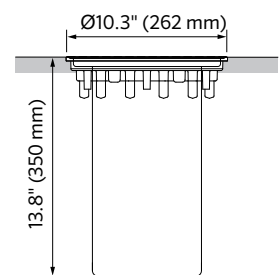
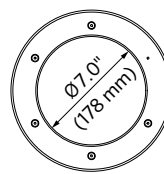

### Specification

Use the table below to specify your Mounting Collar. For more information and other cable options contact Lumascape.

LS640-2	-	84
<b>Connection Type</b>		<b>Code</b>
Flexible cable, single entry, for hardwired installations		84

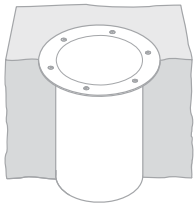

**Direct Burial**

Luminaire is put directly into soil or concrete.

<b>Used for</b>	Landscaping areas Applications where depth is restricted Rate for use in concrete pour applications Economical options
<b>Benefits</b>	Easy removal for servicing
<b>Restrictions</b>	Not as easy to remove for service as pre-installation version Not suitable for drive-over (requires pre-installation kit) Not available with Connection Type '97' (requires pre-installation kit) Connection Type '82' only available for North American market

**Connection type '84'**

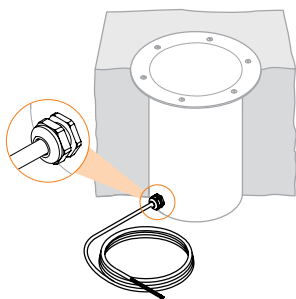

**Flexible Cable**

For connections to the branch circuit via junction box (by others) or other approved method. 6.5' (2.0 m) length. For other length options, contact Lumascape.

**Connection type '82'**  
North American Market only

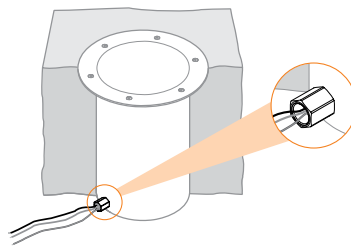

**1/2" NPT Adapter**

The luminaire is factory-fitted with 6.5' (2.0 m) hookup wire. Ensure terminations can be made within this length. For other length options, contact Lumascape.

**Recessed Cover Options**

Use recessed cover for installation in soil, grass, pavers and other uneven surfaces where no cover overhang is desired.



- SS316: Polished
- SS316: Brushed

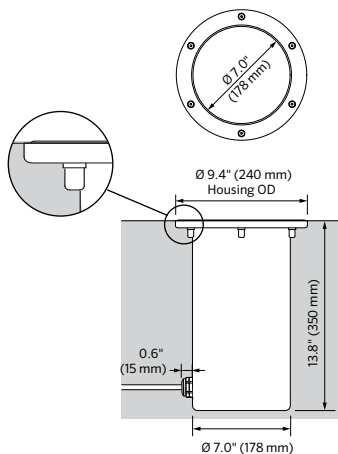

**Flush Cover Options**

Use flush covers for installation in fine finished surfaces such as granite and marble. They can also be used in some suspended applications. The flush cover will conceal gaps between the luminaire and the surrounding surface.



- SS316: Polished
- SS316: Brushed

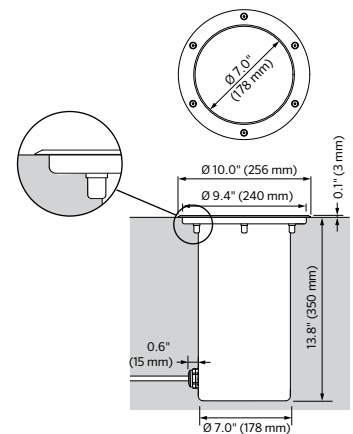



Direct Burial Specification Matrix

<b>LS3080</b>	-	<b>30D</b>								<b>25</b>			<b>PS</b>
---------------	---	------------	--	--	--	--	--	--	--	-----------	--	--	-----------

Light Engine	Code
30 W	30D

Static White & Color	Code
2,700 K (80 CRI)	827
3,000 K (80 CRI)	830
3,500 K (80 CRI)	835
4,000 K (80 CRI)	840
5,000 K (70 CRI)	750

Dynamic Color	Code
RGBA	4CA
RGBW with Royal Blue	4BW

Tunable White	Code
2,700 K - 6,500 K	2WT

**!** Other LED colours and CRIs available on request. Contact Lumascape for options.

Beam Angles	Code
6°	VN
10°	NR
15°	NM
30°	ME
45°	WD
60°	WF
60° x 10°	LH
10° x 60°	LV
40° x 10°	NH
10° x 40°	NV
40° x 20°	MH
20° x 40°	MV
60° x 20°	WH
20° x 60°	WV

Housing Depth	Code
Direct Burial 13.8" (350 mm)	25

Lens	Code
OptiClear™	A
GripGlass™	G

Cable Entry	Code
Side	N
Bottom	Q

Cover	Code
Round recessed, stainless steel, polished	B
Round recessed, stainless steel, brushed	H
Round flush, stainless steel, polished	D
Round flush, stainless steel, brushed	I

Input Voltage	Code
220-240 Vac, 50/60 Hz (International)	01
120/277 Vac, 60 Hz (North America)	09
30-48 Vdc (International)	07
30-48 Vdc (North America)	13

  

Connection Type	Code
Flexible cable, single entry, for hardwired installations	84
Hookup wire and ½" NPT, single entry, for hard wired installations (North America only)	82

  

Control	Code
PowerSync®	PS¹

¹Required for all dimming and color-changing applications (order separately).  
Mains Voltage: LS6540 Data Injector  
Low Voltage: LS6550 Data Injector

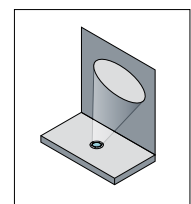

Beam Orientation for "NH" and "WH"

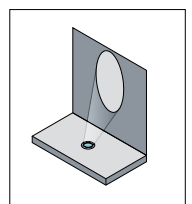

Beam Orientation for "NV" and "WV"

**Network Topology** – Line Voltage 220-240 Vac, 120/277 Vac Dimmable via PowerSync®

**PowerSync™ Topology 1 - Single Trunk Cable**

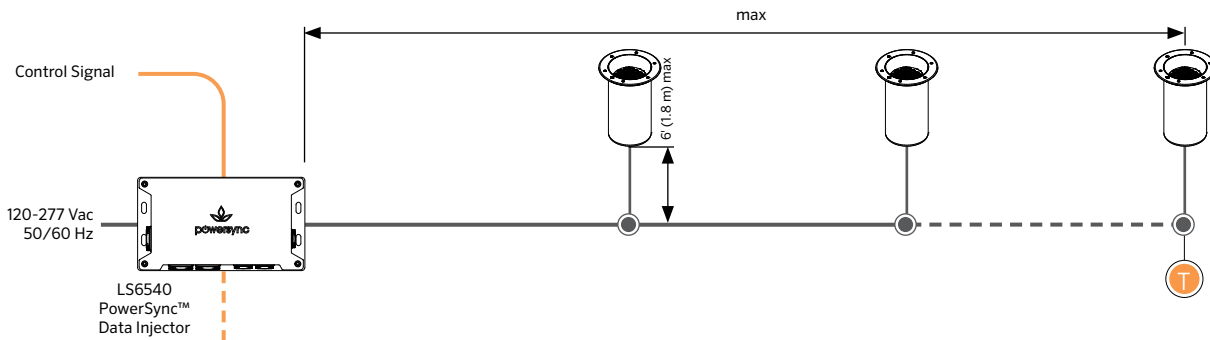

**PowerSync™ Topology 2 - Split Trunk Cable**

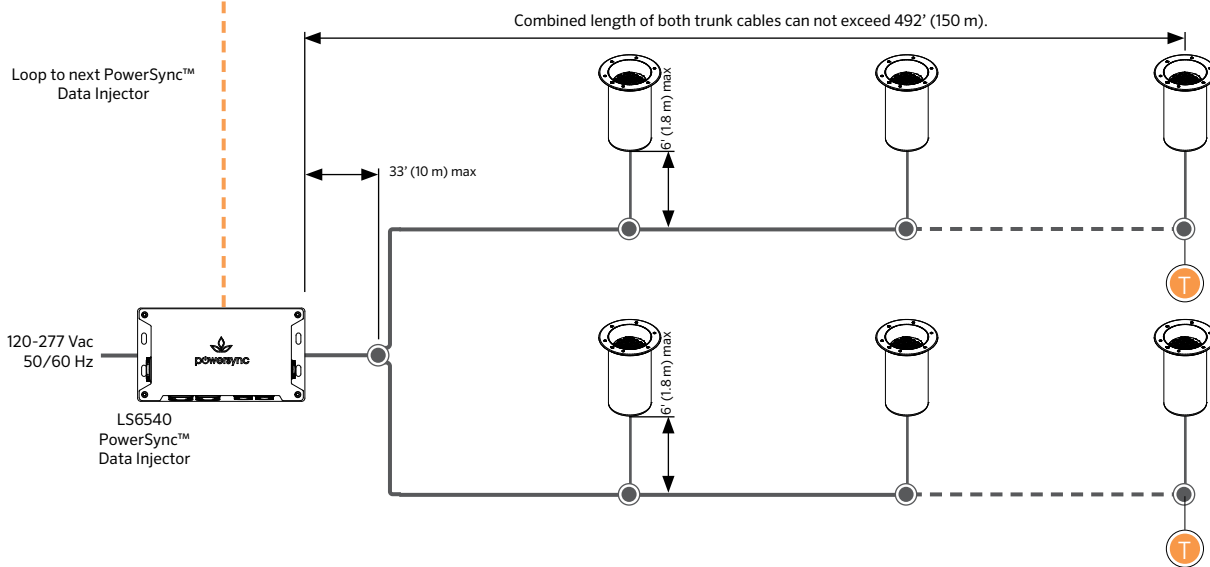

**Up to 45 luminaires per run under the following conditions:**

- Max total cable run length 492' (150 m) in up to two trunk cables
- For run lengths in excess of 100' (30 m), data wire gauge cannot exceed 14 AWG (2.5mm<sup>2</sup>)
- For run lengths up to 100' (30 m), the data wire gauge is not governed
- Refer to 'Maximum Circuit Load' table for circuit limitations
- Always observe local electrical codes for branch circuit current limitations



**Terminator**

Use PowerSync™ terminator, supplied with leader cable to terminate last luminaire in chain.



**Connection Type**

Circuits can be configured as either connectorized or hardwired. For details refer to installation instructions and comply with local electrical codes.

**Maximum Circuit Load**

Maximum Number of Inconnected Fixtures		
Voltage	12A	16A
120 V	30	45
240 V	45	45
277 V	45	45

Refer to PowerSync™ installation instructions for maximum distance information and topology options. Above circuit loading limits are based on maximum circuit current capacity and PowerSync™ control capacity. Cumulative earth leakage and voltage drop may need to be calculated. For non-continuous runs contact factory for details. Local wiring rules and requirements may limit circuit loadings refer to relevant electrical parameters to calculate.

Network Topology - Non-Dimmable

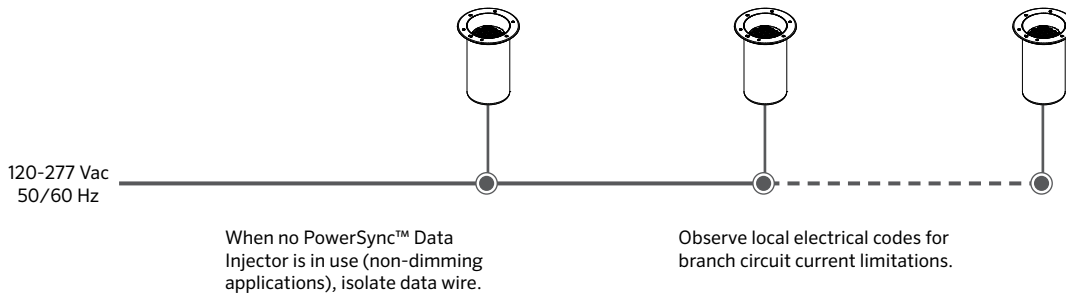

Up to 45 luminaires per run under the following conditions:

- Refer to 'Maximum Circuit Load' table for circuit limitations
- Always observe local electrical codes for branch circuit current limitations

● Connection Type

Circuits can be configured as either connectorised or hardwired. For details consult installation instructions and comply with local electrical codes.

Maximum Circuit Load

Maximum Number of Inconnected Fixtures		
Voltage	12A	16A
120 V	30	45
240 V	45	45
277 V	45	45

Refer to PowerSync™ installation instructions for maximum distance information and typology options.  
 Above circuit loading limits are based on maximum circuit current capacity and PowerSync™ control capacity. Cumulative earth leakage and voltage drop may need to be calculated.  
 For non-continuous runs contact factory for details.  
 Local wiring rules and requirements may limit circuit loadings refer to relevant electrical parameters to calculate.

Connectorized Accessories

Terminators

Product	Code
DMX Terminator Hardwired	LS6407
PowerSync Terminator Hardwired, Line Voltage 220 to 240 Vac	LS6406-01
PowerSync Terminator Hardwired, Line Voltage 120/277 Vac	LS6406-09
PowerSync Terminator Connectorized, Line Voltage 220 to 240 Vac, 120/277 Vac	LS6417

\* NOTE:

- DMX Terminators ship with PowerSync Data Injectors.
- Terminators for hardwired PowerSync installations ship with PowerSync Data Injectors.
- Terminators for connectorized PowerSync installations ship with Leader Cables.
- Order separately for spares only.

PowerSync Line Voltage 220/240 Vac, 120/277 Vac Data Injector

Combines the convenience of standard wiring methods to translate control signals into a digital format that can be transmitted over standard copper wire. This allows highly granular addressing and high-speed digital control of every luminaire, using only four wires and accepts a growing list of standard protocols (0-10V, DMX / RDM), for simple integration with a wide selection of control systems using these industry standard protocols.



Product	Code	Input Voltage	Code	Control	Code	Finish	Code
Data Injector PS4	LS6540	220-240 Vac, 50 Hz (International)	01	DMX/RDM, 0-10 V Input	2D	Black	BL
		120/277 Vac, 60 Hz (North America)	09			Anthracite Gray	AG
						Basalt Gray	BT
						Graphite Gray	GH
						Anodic Silver	SL
						White	WT
						Dark Bronze	DB
						Latte	LT
						Dark Aluminum	DA
						Custom RAL	CC <sup>1</sup>

NOTE:

PowerSync Data Injector ships with three (3) hardwired terminators and one (1) hardwired DMX terminator.

<sup>1</sup>RAL color required

Accessories

PowerSync Low Voltage 30-48 Vdc Data Injector

Translates control signals into a digital format, delivering integral power and data to intelligent LED luminaires. This allows highly-granular addressing and high-speed digital control of every luminaire, using only three wires. The data injector is DIN rail mountable designed to be installed in a switchboard, next to the power supply and circuit breaker that is supplying power to the controlled lighting circuit. Accepts a growing list of standard protocols (0-10 V, DMX/RDM) for simple integration with a wide selection of control systems using these industry standard protocols.

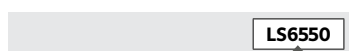

Product	Code
LV Data Injector PS4	LS6550

NOTE:

PowerSync Data Injector ships with three (3) hardwired terminators and one (1) hardwired DMX terminator.

Luminaire Wire Colours & Designations

Line Voltage 220-240 Vac - International

Designation	Color
Line	Brown
Neutral	Blue
Ground/Earth	Green / Yellow
Data	Black

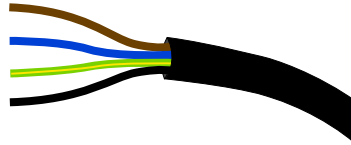

Line Voltage 120/277 Vac - North America

Designation	Color
Line	Black
Neutral	White
Ground/Earth	Green / Yellow
Data	Orange

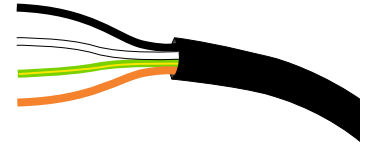

Low Voltage 30-48 Vdc + PowerSync™ - All Markets

Designation	Color
Positive	Red
Negative	Black
Data	Orange

